

MV13_-3,5-H-L

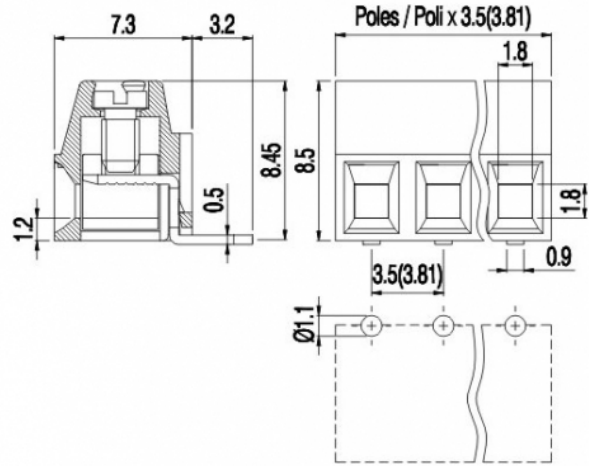
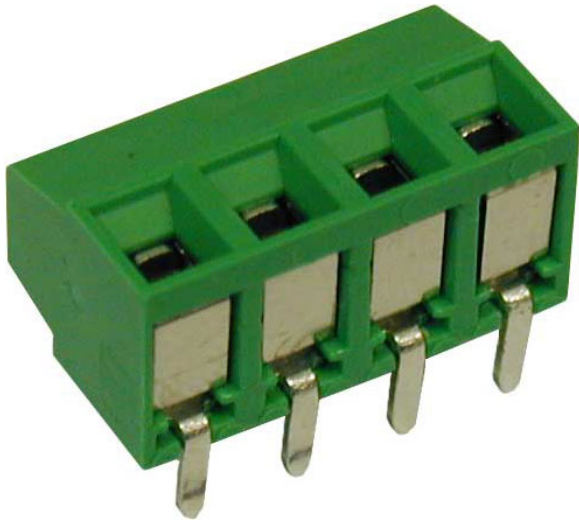

GENERAL INFORMATION

pitch	3,5 mm
Height	8.5 mm
Depth	7.3 mm
Dimensional class	Bassa
Wire section	1.0 mm ² / 16 AWG
Clamp opening size	1.8 x 1.8 mm
Wire stripping	max 6 mm
Operating temperature	-40 ÷ +130 °C

ELECTRICAL CHARACTERISTICS

Current	17,5 A
Voltage	130 V
impulse voltage	1.25 kV

MECHANICAL CHARACTERISTICS

Screw	M2
Recommended torque	0.2÷0.22 Nm / 1.8÷2 in.lbs

APPROVALS DATA



	EN 60998-1		UL 1059
Current	13.5 A	-	12 A factory / 10 A field
Voltage	130 V	-	150 V
Wire section	1.0 mm ²	-	16 AWG
Torque	0.2 Nm	-	1.8 Lb-in
FILE	CA02.04718	-	E178356

MATERIALS

Housing	PA - UL 94 V0
Screw	Galvanized steel
Clamp	Tin-plated copper alloy
Terminal	Tin-plated copper alloy

COLOURS

Standard



On request



POLES	NAME	3D FILE
2	MV132-3,5-H-L	File available
3	MV133-3,5-H-L	File available
4	MV134-3,5-H-L	File available
5	MV135-3,5-H-L	File available
6	MV136-3,5-H-L	File available
7	MV137-3,5-H-L	File available
8	MV138-3,5-H-L	File available
9	MV139-3,5-H-L	File available
10	MV1310-3,5-H-L	File available
11	MV1311-3,5-H-L	File available
12	MV1312-3,5-H-L	File available