

PDV__-3,5-H-P

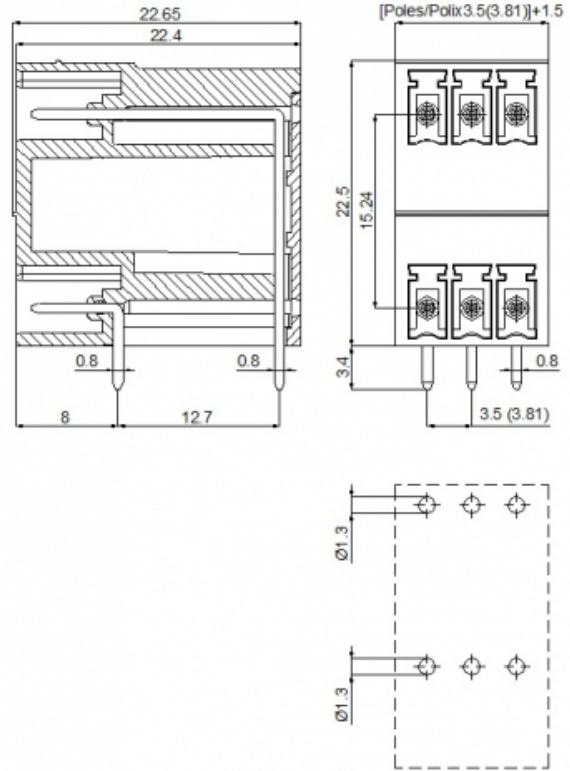
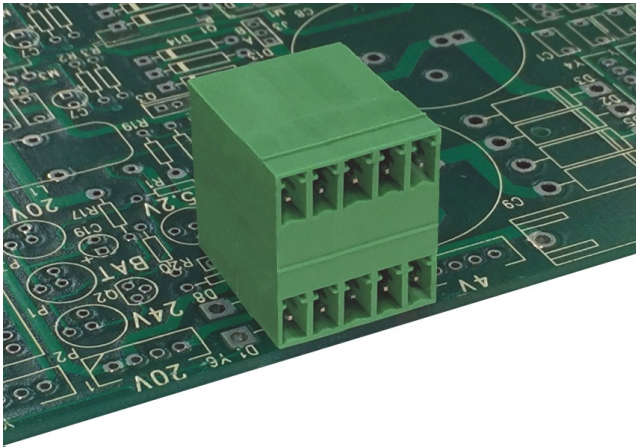

GENERAL INFORMATION

pitch	3,5 mm
Height	22.65 mm
Depth	22.5 mm
Dimensional class	Media
Wire section	-
Clamp opening size	-
Wire stripping	-
Operating temperature	-40 ÷ +130 °C

ELECTRICAL CHARACTERISTICS

Current	11 A
Voltage	160 V
impulse voltage	2.5 kV

MECHANICAL CHARACTERISTICS

Screw	-
Recommended torque	-

APPROVALS DATA



Current	-	EN 61984	8 A	UL 1059	11 A factory / 11 A field
Voltage	-		160 V		300 V
Wire section	-		-		-

Torque - - -
 FILE - 40048261 E178356

MATERIALS

Housing PA - UL 94 V0
 Screw -
 Clamp -
 Terminal Tin-plated copper alloy

COLOURS

Standard



On request



POLES

NAME

3D FILE

02	PDV02-3,5-H-P	File not available for this product
03	PDV03-3,5-H-P	File not available for this product