

MVS17_-7,5-V-L

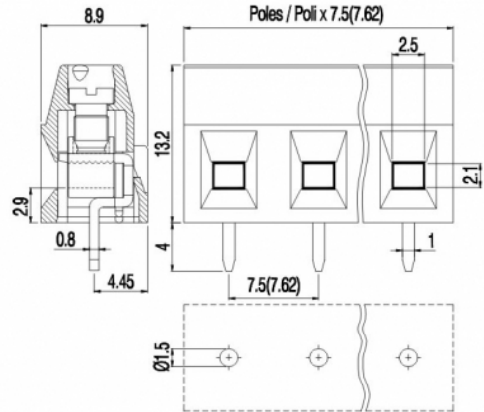
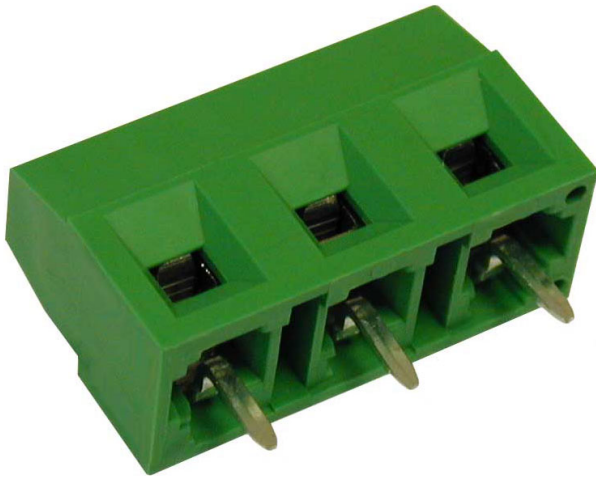

Version with antirotation pegs is available on 2 poles connections.
Disponibile per connessioni a 2 poli versioni con perni antitorzione.

GENERAL INFORMATION

pitch	7,5 mm
Height	13.2 mm
Depth	8.9 mm
Dimensional class	Bassa
Wire section	1.5 mm ² / 16 AWG
Clamp opening size	2.5 x 2.1 mm
Wire stripping	max 7 mm
Operating temperature	-40 ÷ +130 °C

ELECTRICAL CHARACTERISTICS

Current	17.5 A
Voltage	750 V
impulse voltage	3 kV

MECHANICAL CHARACTERISTICS

Screw	M3
Recommended torque	0.5÷0.55 Nm / 4.5÷4.9 in.lbs

APPROVALS DATA



	EN 60998-1		UL 1059
Current	17.5 A	-	17.5 A factory / 10 A field
Voltage	750 V	-	300 V
Wire section	1.5 mm ²	-	16 AWG
Torque	0.5 Nm	-	4.5 Lb-in
FILE	CA02.00598	-	E178356

MATERIALS

Housing	PA - UL 94 V0
Screw	Galvanized steel
Clamp	Nickel-plated copper alloy
Terminal	Tin-plated copper alloy
SCIP Number	2e7d6973-4e16-4203-958f-24d6cd681252

COLOURS

Standard

On request



POLES	NAME	3D FILE
2	MVS172-7,5-V-L	File not available for this product
3	MVS173-7,5-V-L	File not available for this product
4	MVS174-7,5-V-L	File not available for this product
5	MVS175-7,5-V-L	File not available for this product
6	MVS176-7,5-V-L	File not available for this product
7	MVS177-7,5-V-L	File not available for this product
8	MVS178-7,5-V-L	File not available for this product
9	MVS179-7,5-V-L	File not available for this product
10	MVS1710-7,5-V-L	File not available for this product
11	MVS1711-7,5-V-L	File not available for this product
12	MVS1712-7,5-V-L	File not available for this product